

Rysunek 1

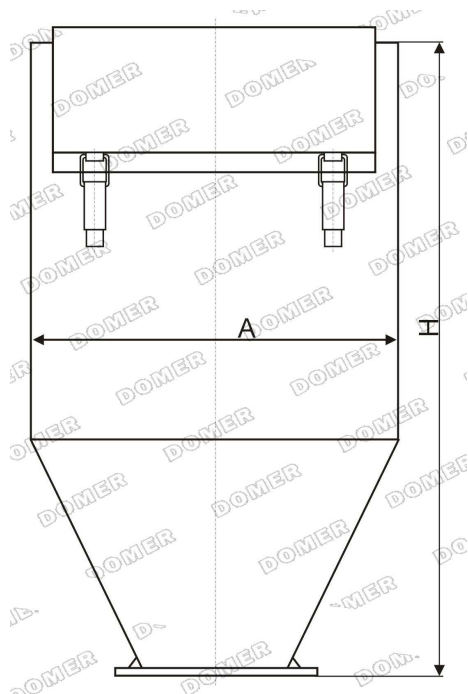

Rysunek 2

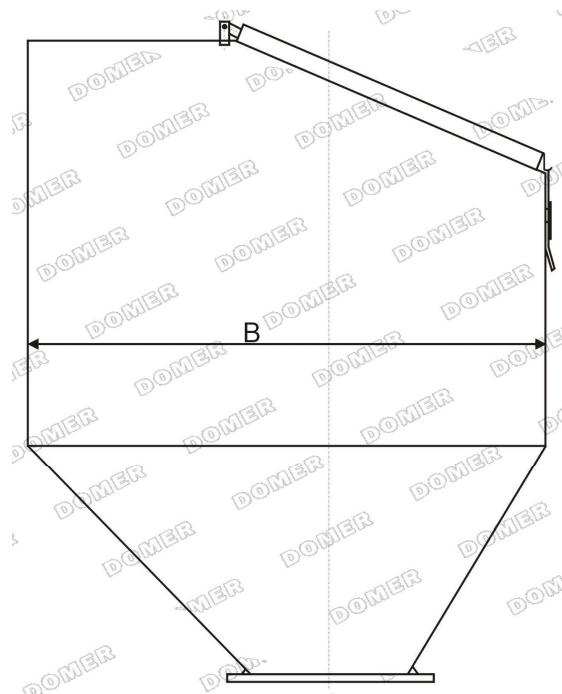

Rysunek 3 – Kołnierz przyłączeniowy



Tabela wymiarowa

Parametr	Wartość
A	500 mm
B	600 mm
H	900 mm
L1	240 mm
L2	220 mm
L3	190 mm
L4	210 mm
Pojemność	215 dm ³

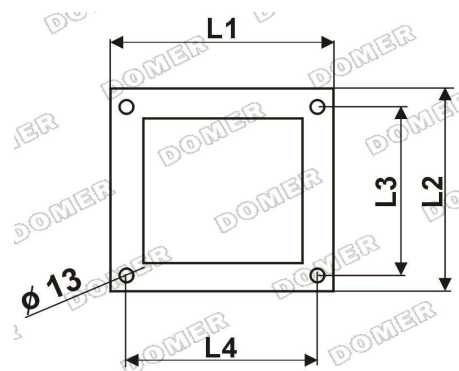